

Turmdrehkran

Tower Crane / Grue à tour / Gru a torre / Grúa torre /
Guindaste de torre / Башенный поворотный кран

202 EC-B 10 Litronic®

TADEX ZURAWIE - www.dzwigi-budowlane.pl

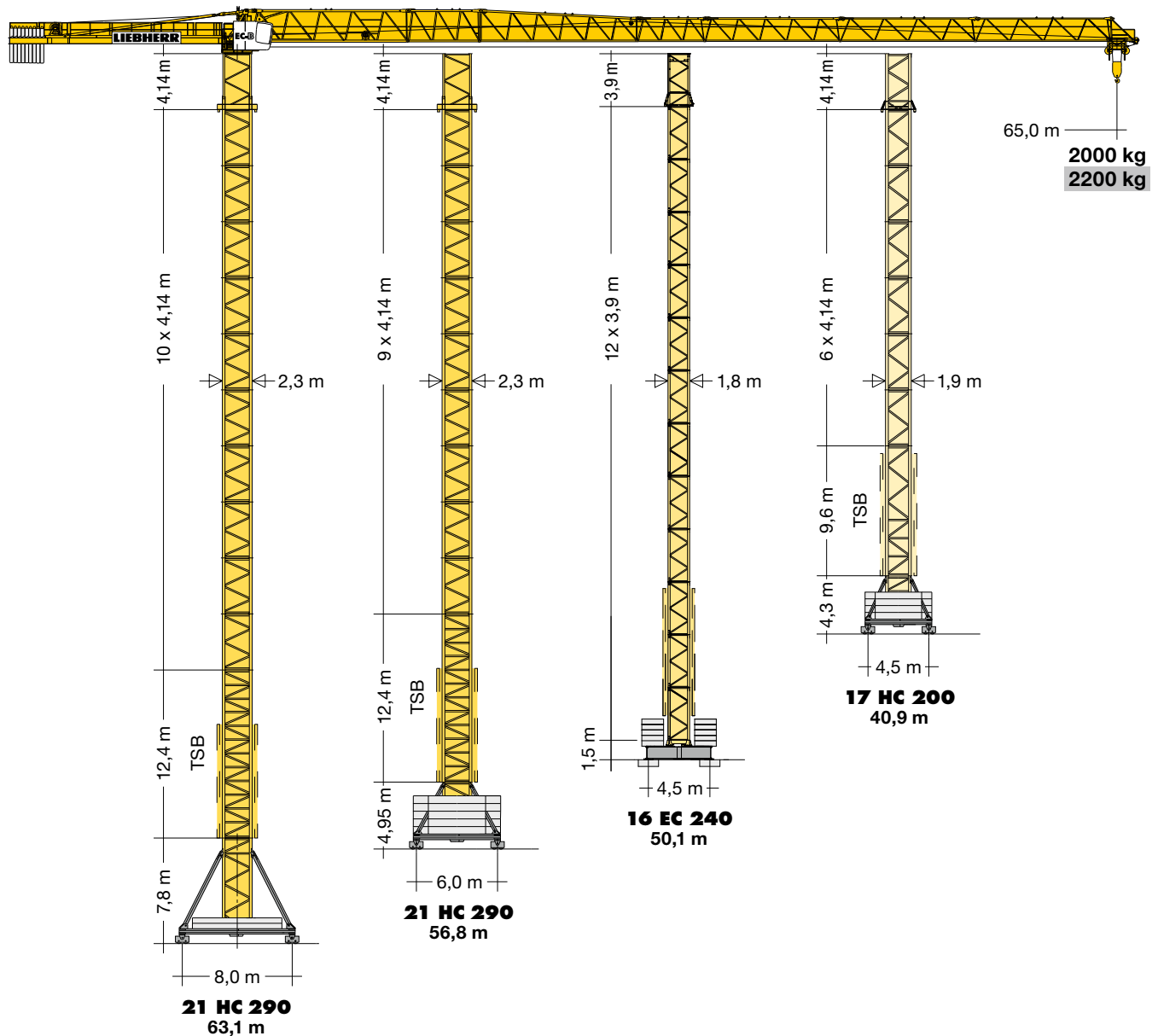

EN 14439:2009 – C25

TADEX ZURAWIE, 62-030 Lubon, ul. Dworcowa 47, tadex@dzwigi-budowlane.pl, sprzedaz@dzwigi-budowlane.pl, +48 61 8666 777

LIEBHERR

Made With PdfOffice

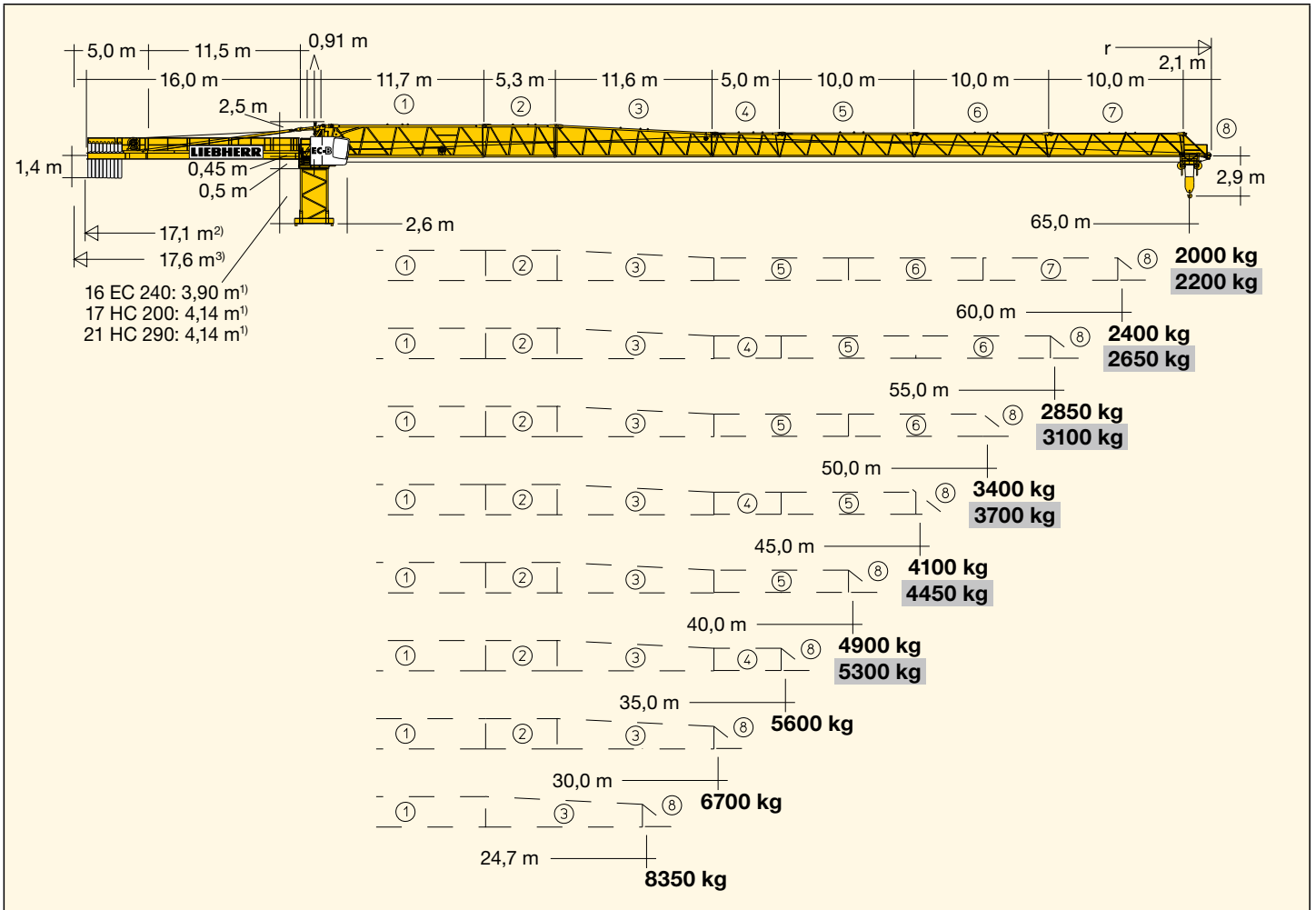

¹⁾ Turmstück oder Kletterturmstück / Tower section or climbing tower section / Élément de mât ou élément de mât télescopable / Elemento torre oppure elemento torre telescopabile / Tramo torre o tramo torre trepable / Segmento de torre ou segmento de torre para ascensão / Башенная секция или секция наращивания

²⁾ nicht geteilt / not split / non divisé / non suddiviso / no divisible / não fraccionável / цельная

³⁾ geteilt / split / divisé / suddiviso / divisible / fraccionável / составная

		202 EC-B 10											
m	r	m/kg	m/kg										
			19,0	22,0	25,0	30,0	35,0	40,0	45,0	50,0	55,0	60,0	65,0
65,0	(r=66,8)	2,6 – 17,7 10000	9260	7870	6800	5510	4580	3880	3340	2900	2550	2250	2000
60,0	(r=61,8)	2,6 – 18,5 10000	9730	8270	7160	5800	4830	4100	3540	3080	2710	2400	
55,0	(r=56,8)	2,6 – 19,2 10000	10000	8620	7470	6060	5050	4300	3710	3240	2850		
50,0	(r=51,8)	2,6 – 20,0 10000	10000	8990	7800	6330	5290	4500	3890	3400			
45,0	(r=46,8)	2,6 – 20,8 10000	10000	9420	8170	6650	5560	4740	4100				
40,0	(r=41,8)	2,6 – 21,4 10000	10000	9710	8430	6860	5740	4900					
35,0	(r=36,8)	2,6 – 21,0 10000	10000	9490	8230	6700	5600						
30,0	(r=31,8)	2,6 – 21,0 10000	10000	9490	8240	6700							
24,7	(r=26,5)	2,6 – 21,0 10000	10000	9490	8350								

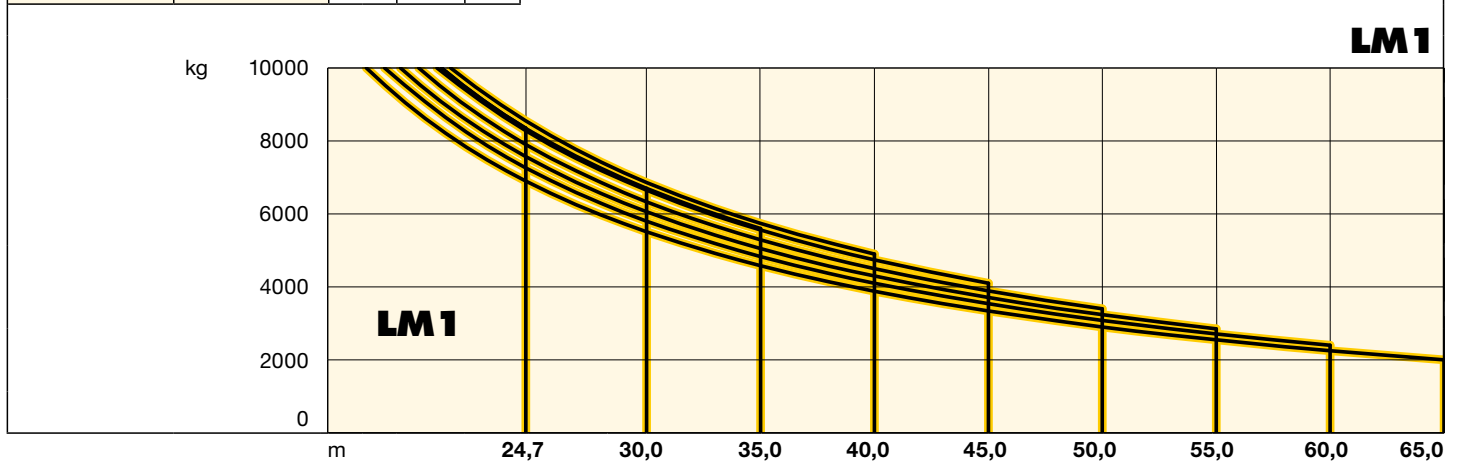

		202 EC-B 10 Litronic®											
m	r	m/kg	m/kg										
			19,0	22,0	25,0	30,0	35,0	40,0	45,0	50,0	55,0	60,0	65,0
65,0	(r=66,8)	2,6 – 18,9 10000	9940	8450	7320	5940	4950	4210	3630	3160	2780	2470	2200
60,0	(r=61,8)	2,6 – 19,9 10000	10000	8950	7760	6300	5260	4480	3870	3380	2980	2650	
55,0	(r=56,8)	2,6 – 20,5 10000	10000	9240	8020	6520	5440	4640	4010	3510	3100		
50,0	(r=51,8)	2,6 – 21,3 10000	10000	9670	8390	6830	5710	4880	4220	3700			
45,0	(r=46,8)	2,6 – 22,3 10000	10000	10000	8800	7170	6010	5130	4450				
40,0	(r=41,8)	2,6 – 22,9 10000	10000	10000	9070	7400	6200	5300					

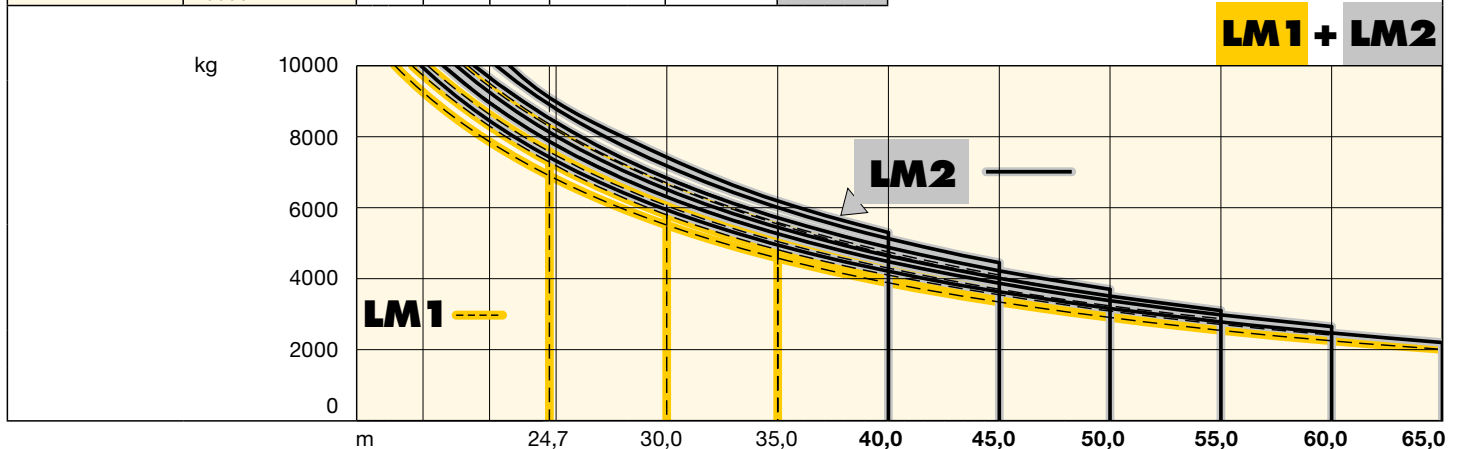

LM 2 = Abweichende Geschwindigkeiten und Betriebsbedingungen. / Variant speeds and service conditions. / Vitesses et conditions de fonctionnement différentes. / Differenti velocità e condizioni di funzionamento. / Otras velocidades y características de funcionamiento. / Outras velocidades e características de funcionamento. / Нестандартные скорости и условия эксплуатации.

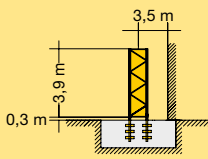
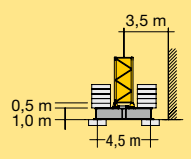
3,9 m		3,90 m + 5,85 m	16 EC 240	
				
12	12 + 1		50,9 ^{*)}	—
			49,0 ^{*)}	50,1 ^{*)}
11	11 + 1		47,0 ^{*)}	48,2 ^{*)}
			45,1	46,2 ^{*)}
10	10 + 1		43,1	44,3
			41,2	42,3
9	9 + 1		39,2	40,4
			37,3	38,4
8	8 + 1		35,3	36,5
			33,4	34,5
7	7 + 1		31,4	32,6
			29,5	30,6
6	6 + 1		27,5	28,7
			25,6	26,7
5	5 + 1		23,6	24,8
			21,7	22,8
4	4 + 1		19,7	20,9
			17,8	18,9
3	3 + 1		15,8	17,0
			13,9	15,0
2	2 + 1		11,9	13,1
			9,9	11,1
1	1 + 1		8,0	9,1
0			6,0	7,2
			2,1	3,3
		m		m
				
		20 EC 300 FA		20 EC 300 CB-0450m

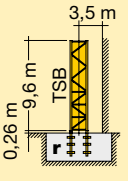
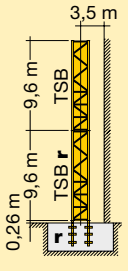
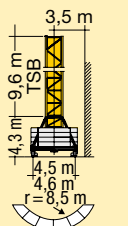
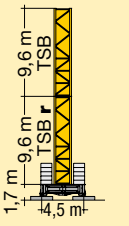
C 25		17 HC 200			
12	—	—	—	—	—
11	—	—	—	—	—
10	—	—	—	—	—
9	—	—	—	—	—
8	—	—	—	—	—
7	41,0 ^{*)}	50,6 ^{*)}	—	—	51,7 ^{*)}
6	36,9	46,5	40,9 ^{*)}	—	47,5
5	32,7	42,3	36,8	—	43,4
4	28,6	38,2	32,6	—	39,2
3	24,5	34,1	28,5	—	35,1
2	20,3	29,9	24,4	—	31,0
1	16,2	25,8	20,2	—	26,8
0	12,0	21,6	16,1	—	22,7
	m	m	m	m	m
					
	21 HC 290 FAR	21 HC 290 FAR	17 HC 200 UC-0460r	21 HC 290 CB-0450	

^{*)}  **r = verstärkt / reinforced / renforcé / rinforzato / reforzado / reforçado / усиленный**

Weitere Hubhöhen, Auslegerlängen sowie Klettern im Gebäude auf Anfrage. / Further hoist heights and jib lengths as well as climbing inside the building on request. / Autres hauteurs sous crochet et longueurs de flèche ainsi que hissage dans le bâtiment sur demande. / Ulteriori altezze gancho, lunghezze braccio così come telescopaggio all'interno dell'edificio: su richiesta. / Para alturas bajo gancho superiores, otros alcances y trepado en el interior del edificio, consultar. / Outras alturas de elevação, comprimentos de lança e subida no edifício: sob consulta. / Другие высоты подъема, длины стрелы и самоподъем в здании – по запросу.су.

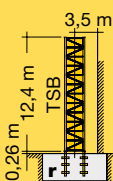
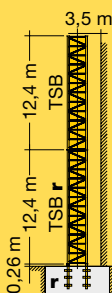
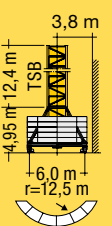
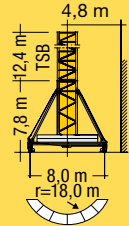
21 HC 290				
C 25				
12	-	-	-	-
11	60,4*)	-	-	-
10	56,3	68,7*)	-	63,1*) ⁴⁾
9	52,1	64,5	56,8*)	59,7*)
8	48,0	60,4	52,7	55,5
7	43,9	56,3	48,5	51,4
6	39,7	52,1	44,4	47,2
5	35,6	48,0	40,3	43,1
4	31,4	43,8	36,1	39,0
3	27,3	39,7	32,0	34,8
2	23,2	35,6	27,8	30,7
1	19,0	31,4	23,7	26,5
0	14,9	27,3	19,6	22,4
	m	m	m	m
	 21 HC 290 FAr	 21 HC 290 FAr	 21 HC 290 UC-0600	 21 HC 290 UC-0800

*)  4) **ohne Fahrwerke** / without Travel Gear / sans boogie / senza dispositivi di traslazione / sin cajas de traslación / sem mecanismo de translação / без механизмов передвижения
r = verstärkt / reinforced / renforcé / rinforzato / reforzado / reforçado / усиленный
Weitere Hubhöhen, Auslegerlängen sowie Klettern im Gebäude auf Anfrage. / Further hoist heights and jib lengths as well as climbing inside the building on request. /
 Autres hauteurs sous crochet et longueurs de flèche ainsi que hissage dans le bâtiment sur demande. / Ulteriori altezze ganccio, lunghezze braccio così come telescopaggio
 all'interno dell' edificio: su richiesta. / Para alturas bajo gancho superiores, otros alcances y trepado en el interior del edificio, consultar. / Outras alturas de elevação,
 comprimentos de lança e subida no edifício: sob consulta. / Другие высоты подъема, длины стрелы и самоподъем в здании – по запросу.су.

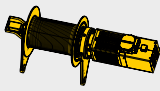

↔ **stufenlos/stepless/régl. continu/**
regl. progressiva/sin escalones/
sem degraus/бесступенчатый
 kg m/min

37 kW FU
 WIW 250 MZ 416

5 Lagen
 Layers
 Couches
 Avvolgimenti
 Camadas
 Capas
 Слоёв

1 10000 0 ↔ 19
 600 0 ↔ 116

160,0 m
 278,0 m⁵⁾

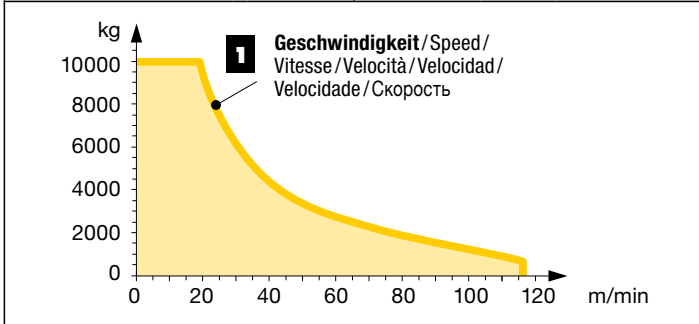
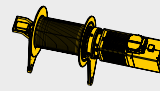
↔ **stufenlos/stepless/régl. continu/**
regl. progressiva/sin escalones/
sem degraus/бесступенчатый
 kg m/min

45 kW FU
 WIW 260 MZ 420

6 Lagen
 Layers
 Couches
 Avvolgimenti
 Camadas
 Capas
 Слоёв

1 10000 0 ↔ 23
 650 0 ↔ 139

198,0 m
 321,0 m⁵⁾

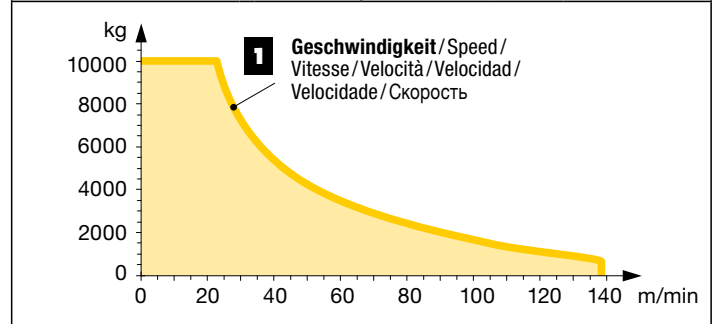
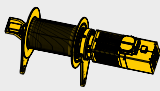
↔ **stufenlos/stepless/régl. continu/**
regl. progressiva/sin escalones/
sem degraus/бесступенчатый
 kg m/min

65 kW FU
 WIW 280 MZ 417

6 Lagen
 Layers
 Couches
 Avvolgimenti
 Camadas
 Capas
 Слоёв

1 10000 0 ↔ 33
 2000 0 ↔ 139

198,0 m
 321,0 m⁵⁾

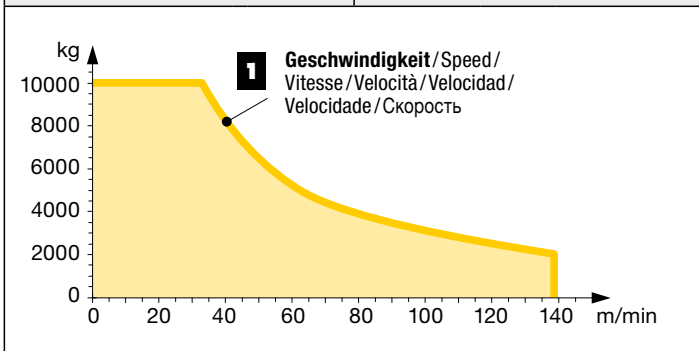

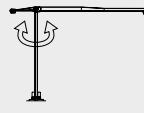
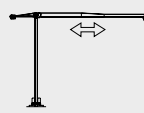
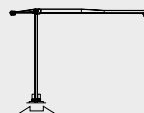

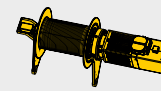















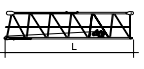



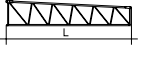

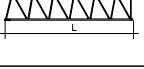



	0 ↔ U/min 0,8 sl./min tr./min	2 x 7,5 kW FU
	0 ↔ 100,0 m/min	5,5 kW FU
	25,0 m/min	2 x 5,5 kW (170 HC 200) 2 x 7,5 kW (21 HC 290)



	37 kW FU	45 kW FU	65 kW FU
	kVA 54,0	61,0	83,0

⁵⁾ Weitere Hublastdaten: siehe Betriebsanleitung. / Further hoist load data: see instruction manual. / Autres données de la charge de levage : voir manuel d'instruction. / Altri dati sui carichi sollevati: consultare il manuale d'istruzione. / Alturas bajo granchos superiores según manual. / Outras tabelas de carga: consultar manual de instruções. / Другие данные по весу поднимаемых грузов: см. инструкцию по эксплуатации.

kVA reduzierbar bei zu geringer Netz-Anschlussleistung, siehe BAL. / kVA can be reduced in case of too little power of the mains, see instruction manual. / kVA peut être réduit en cas de trop faible puissance du réseau, voir manuel d'instruction. / kVA riducibili in caso di potenza di rete ridotta (si veda manuale uso e manutenzione) / kVA variable para potencia de red demasiado pequeña, ver Manual de instrucciones. / kVA reduzível no caso de capacidade da rede elétrica muito baixa, ver manual de instruções. / Количество кВА может быть сокращено до минимальной общей потребляемой мощности, см. инструкцию по эксплуатации.





Kranoberteil		Upper part of crane / Partie supérieure de grue / Parte superiore della gru / Parte superior grúa / Parte superior do guindaste / Верхняя часть крана		L (m)	B (m)	H (m)	kg⁶⁾	
Pos. Anz. Item Qty. Rep. Qte. Voce Qta. Pos. Cant. Ref. Cant. Поз. Кол-во	Drehbühne mit Schaltschrank / Slewing platform with switch cabinet / Plate-forme tournante avec armoire électrique / Piattaforma girevole con quadro elettrico / Plataforma giratoria con armario eléctrico / Plataforma giratória com armário elétrico / 1a 1 Поворотная платформа с электрощафом			17 HC 200 21 HC 290 16 EC 240	4,02 4,02 4,02	2,30 2,30 2,45	2,35 2,39 2,45	6570 6690 6640
1b 1	Klappspitze / Folding jib head / Pointe de flèche pliante / Punta ribaltabile / Pluma / Ponta da lança dobrável / Откидной кронштейн				1,68	1,51	2,27	1140
1c 1	Kabine / Cabin / Cabine / Cabina / Cabina / Cabina / Кабина				2,31	1,94	2,41	1000
2 1	Gegenausleger / Counter-jib / Contre-flèche / Controffrecia / Contrapluma / Contra-lança / Консоль противовеса				a) 16,10 b) 11,80	2,40 2,45	1,61 2,54	8400 10300
3 1	Ausleger-Anlenkstück / Jib heel section / Pied de flèche / Sezione articolata braccio / Pluma tramo primero / Base articulada de lança / Корневая секция стрелы				11,98	1,41	2,56	① 4200
4 1	Ausleger-Zwischenstück / Intermediate jib section / Élément intermédiaire de flèche / Sezione intermedia braccio / Tramo intermedio pluma / Peça suplementar da lança / Промежуточная секция стрелы				5,60	1,35	2,49	② 1340
5 1	Ausleger-Zwischenstück / Intermediate jib section / Élément intermédiaire de flèche / Sezione intermedia braccio / Tramo intermedio pluma / Peça suplementar da lança / Промежуточная секция стрелы				11,90	1,35	2,43	③ 2200
6 1	Ausleger-Zwischenstück / Intermediate jib section / Élément intermédiaire de flèche / Sezione intermedia braccio / Tramo intermedio pluma / Peça suplementar da lança / Промежуточная секция стрелы				5,24 10,24 10,24 10,24	1,35 1,35 1,35 1,35	1,84 1,86 1,86 1,86	④ 860 ⑤ 1370 ⑥ 1020 ⑦ 720
7 1	Ausleger-Kopfstück / Jib head section / Pointe de flèche / Punta braccio / Tramo punta de pluma / Cabeça de lança / Концевая секция стрелы				2,20	1,54	2,05	⑧ 260
8 1	Laufkatze und Lasthaken / Trolley and hook / Chariot de distribution et crochet / Carrello con gancio / Carrito y gancho / Carro de ponte e gancho / Грузовая тележка и грузовой крюк				1,87	1,54	1,51	930
Turm		Tower / Mât / Torre / Torre / Torre / Башня						
10 7 11 13	Turmstück / Tower section / Élément de mât / Elemento di torre / Tramo torre / Torre / Башенная секция			16 EC 160/240 TST-0390c 16 EC 240 TS-0390c 16 EC 240 TS-0585 17 HC 200 TS-0414c 21 HC 290 TS-0414c 21 HC 290 TS-0414cr	4,21 4,21 6,16 4,14 4,14 4,14	1,60 1,60 1,60 1,90 2,30 2,30	1,72 1,72 1,60 1,90 2,30 2,30	2130 2120 2850 1940 2500 2950
10 3	Turmstück lang / Long tower section / Élément de mât long / Elemento di torre, lungo / Tramo de torre largo / Peça de torre, comprida / Башенная секция, длинная			21 HC 290 TS-1242c	12,42	2,30	2,30	6100
11 1	Grundturmstück / Base tower section / Mât de base / Elemento di torre base / Tramo base / Peça de base de torre / Секция основания			17 HC 200 TS-0960c 17 HC 200 TS-0960r 21 HC 290 TSB-1242c 21 HC 290 TSB-1242r	9,60 9,60 12,42 12,42	1,90 1,90 2,30 2,30	1,90 1,90 2,30 2,30	4580 5450 8200 8100
12 1	Kletterturmstück / Climbing tower section / Élément de hissage de mât / Elemento torre di telescopaggio / Tramo de trepado / Tramo de telescopagem / Секция самоподъема			21 HC 290 ECTS-0414	4,14	2,30	2,45	3300

Pos. Anz.
Item Qty.
Rep Qte.
Voce Qta.
Pos. Cant.
Ref. Cant.
Поз. Кол-во

L (m) B (m) H (m) kg⁶⁾

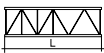

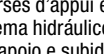









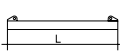

Klettereinrichtung

Climbing equipment / Equipement de télescopiaje / Attrezzatura per allungamento della gru /
Equipo de trepado / Acesoários p. subida no edificio / Обойма наращивания

13	1	Führungsstück kpl. / Guide section cpl. / Cage télescopique cpl. / Gabbia di sopraelevazione compl. / Torre de montaje completa / Peça de guia compl. / Направляющая секция в сб.			17 HC 200 ECGS	9,27	2,48	2,30	4700
					21 HC 290 ECGS	8,39	2,80	2,70 (3,04)	5800
14	1	Hydraulikanlage, Stütz- und Klettertraverse / Hydraulic unit, supporting and climbing crossmembers / Système hydraul. avec traverses d'appui et de télescop. / Sist. idraul., traversa di appoggio e allugam. gru / Sistema hidráulico con traviesa de apoyo y trepado / Instalação hidráulica, travessa de apoio e subida / Гидроагрегат, стойка-упор и траверса обоймы наращивания			17 HC 200 ECP	2,00	1,10	1,00	1150
					21 HC 290 ECP	2,30	1,25	1,00	1150





Unterwagen

Undercarriage / Châssis / Carro /
Carro con mástil / Carro de guindaste / Опорная рама

15	2	Fahrschemel mit Antrieb / Rail bogie with drive / Bogie moteur / Telajo con grappa propulsore / Caja rodillo motriz / Quadra sem grupa de propulsão / Подрамник с приводом			17 HC 200	1,46	0,84	0,87	920
					21 HC 290	1,63	0,92	0,95	1690
16	2	Fahrschemel ohne Antrieb / Rail bogie without drive / Bogie fou / Telajo senza grappa propulsore / Caja rodillo conducido / Quadra com grupa de propulsão / Подрамник без привода			17 HC 200	1,15	0,60	0,87	880
					21 HC 290	1,37	0,62	0,95	1340
17	1	Tragholm lang / Long support arm / Longeron long / Longherone lungo / Brazo soporte largo / Travessa comprida / Несущая балка, длинная			17 HC 200	7,15	0,80	0,70	1070
					21 HC 290	9,10 (11,95)	0,80 (0,82)	0,80 (0,80)	1650 (2200)
18	2	Tragholm kurz / Short support arm / Longeron court / Longherone corto / Brazo soporte corto / Travessa curta / Несущая балка, короткая			17 HC 200	3,45	0,60	0,70	500
					21 HC 290	4,45 (5,58)	0,77 (0,65)	0,77 (0,77)	800 (1040)
19	2+2	Randträger / Border support / Traverse / Supporti base Traviesa / Apoio de bordo / Стяжная балка			17 HC 200	4,08 – 4,30	0,16 – 0,33	0,11 – 0,14	80 – 200
					21 HC 290	5,46 – 5,40 (7,52 – 7,46)	0,11 – 0,18 (0,10 – 0,17)	0,16 – 0,38 (0,10 – 0,38)	175 – 525 (370 – 915)
20	4	Stützholm / Support strut / Hauban de châssis / Correnti di appoggio / Tirante vertical / Travessa de apoio / Опорный подкос			17 HC 200	3,53	0,25	0,17	240
					21 HC 290	4,14 (6,55)	0,18 (0,22)	0,25 (0,25)	320 (600)
21	1	Unterwagen-Turmstück / Undercarriage tower section / Mât de châssis / Elemento di torre del carro / Tramo de carro / Peça de torre do chassis / Опорная башенная секция			17 HC 200	3,30	2,15	2,15	2100
					21 HC 290	3,73 (6,70)	2,62 (2,53)	2,62 (2,53)	2920 (4030)
22	1	Stapel Aufstiege und Podeste / Bundle of ladders and platforms / Faisceau d'échelles et de plates-formes / Serie di scale e rampe / Paquete de escaleras y plataformas / Escadas e patamares / Лестницы и площадки			3,50	1,20	1,00	1000	
23	1	Kiste mit Kleinteilen / Crate with small parts / Caisse contenant des accessoires / Cassa con accessori / Caja con accesorios / Caixa de acessórios / Ящик с мелкими деталями			2,00	1,00	1,00	2000	

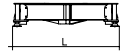
Fundamentkreuz

Cruciform base / Châssis en croix / Crociera /
Carro de guindaste / Base cruciforme / Фундаментная крестовина

24	1	Hauptträger / Main beam / Poutre principale / Traversa portante / Viga principal / Travessa comprida / основная балка			21 HC 290 CB-0450	6,95	0,81	1,23	4600
					21 HC 290 CB-0450	6,95	0,71	1,23	5000
					20 EC 300 CB-0450m (6,86)		(0,87)	(1,00)	(3550)
					20 EC 300 CB-0450m (6,86)		(0,71)	(1,18)	(3950)
25	4	Randträger mit Aufstieg / Edge beam with access / Poutre de rive avec accès / Traversa laterale con scala / Tirantes con acceso / Travessa da base com acesso / стяжная балка с лестницей			21 HC 290 CB-0450	3,67	1,20	0,50	400
					20 EC 300 CB-0450m	4,12	0,22	0,76	340

() Angaben in Klammern gelten für 8 m-Unterwagen. / The data in brackets are valid for an undercarriage of 8 m. / Les données techniques indiquées entre parenthèses sont valables pour un châssis de 8 m. / Caratteristiche in (.) valgono per carro di 8 m. / Los datos entre paréntesis son válidos para carro de 8 m. / Características em (.) válidas pelo chassis de 8 m. / Данные в скобках относятся к 8-метровой опорной раме.

⁶⁾ Einzelgewichte / Single weights / Poids individuels / Singoli pesi / Tramo punta de pluma / Pesos de peças componentes / Индивидуальный вес

TADEx ZURAWIE, 62-030 Lubon, ul. Dworcowa 47, tadox@dzwigi-budowlane.pl, sprzedaz@dzwigi-budowlane.pl, +48 61 8666 777

Änderungen vorbehalten! / Subject to technical modifications! /
Sous réserves de modifications! / Con riserva di modifiche! /
¡Sujeto a modificaciones sin previo aviso! / Sujeto a modificações! /
С правом внесения изменений!

Sämtliche Angaben erfolgen ohne Gewähr. / This information is supplied without liability. /
Ces renseignements sont sans garantie. / Tutte le indicazioni fornite senza garanzia. /
Declinamos toda responsabilidad derivada de la información proporcionada. / Declinamos
qualquer responsabilidade quanto à informação fornecida. / Все данные указаны без обязательств.

TCS-001032-LBC-01 • EN 14439:2009 – A3 • BGL C.0.10.0180 • 04.19

Printed in Germany.

Liebherr-Werk Biberach GmbH
Postfach 1663, D-88396 Biberach an der Riss
☎ +49 73 51 41-0, Fax: +49 73 51 41 22 25
www.liebherr.com, E-Mail: info.lbc@liebherr.com

Liebherr Industrias Metálicas, S.A.
Polígono Industrial Agustinos, calle E, E-31014 Pamplona
☎ +34 94829 70-00, Fax +34 94829 70-29
www.liebherr.com, E-Mail: info.lim@liebherr.com



202 EC 110 117
Made With Pdf Office