

LIEBHERR

TADEX ŻURAWIE
62-030 Luboń/k Poznań, ul. Dworcowa 47
tel. +48 61 8 666 777, +48 601 149 358
www.dzwigi-budowlane.pl, tadex@dzwigi-budowlane.pl

ŻURAW WIEŻOWY LH-45EC

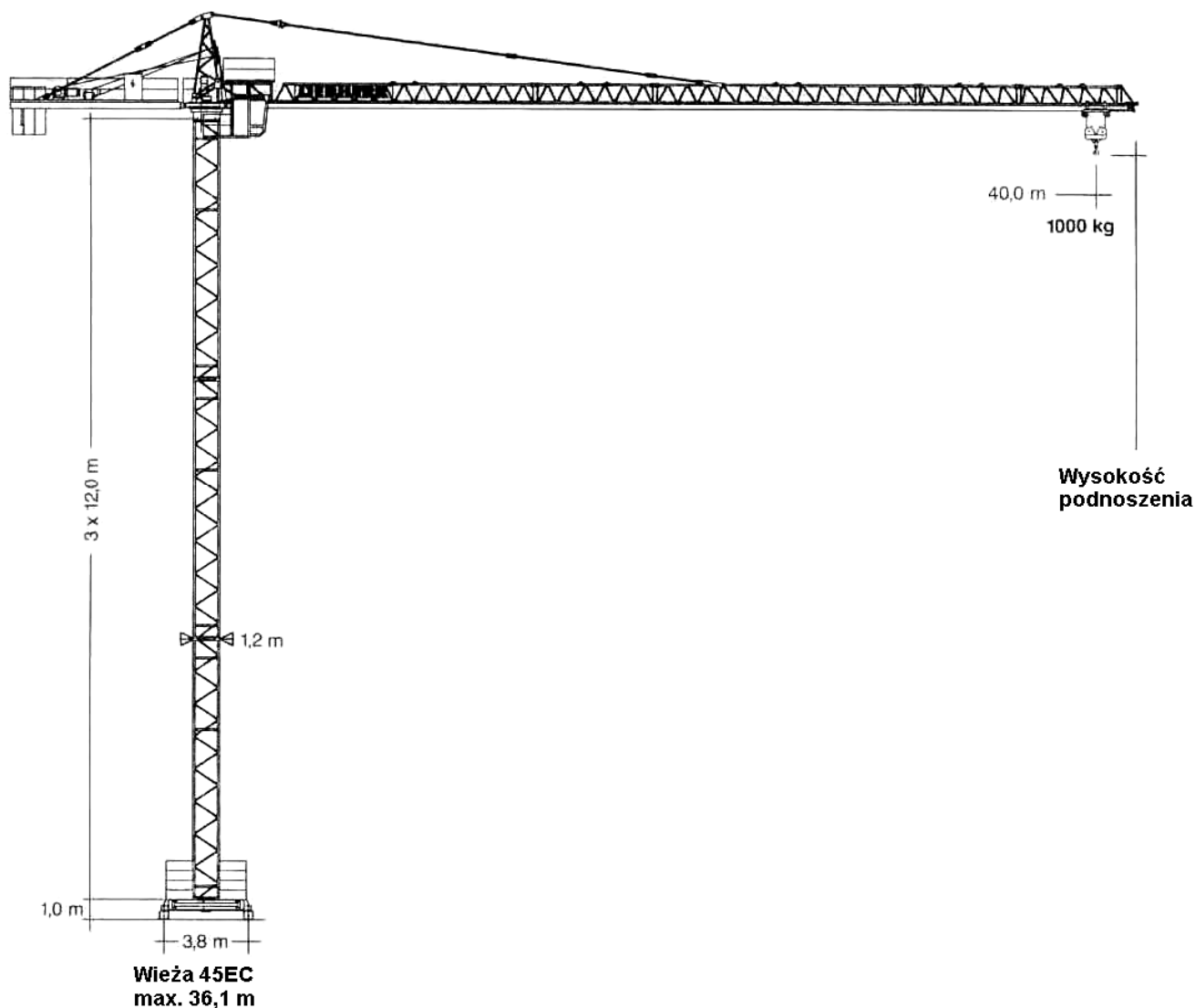

TADEX ŻURAWIE, 62-030 Luboń, ul. Dworcowa 47
Tel. +48 61 8666 777, kom. +48 601 149 358
www.dzwigi-budowlane.pl, tadex@dzwigi-budowlane.pl



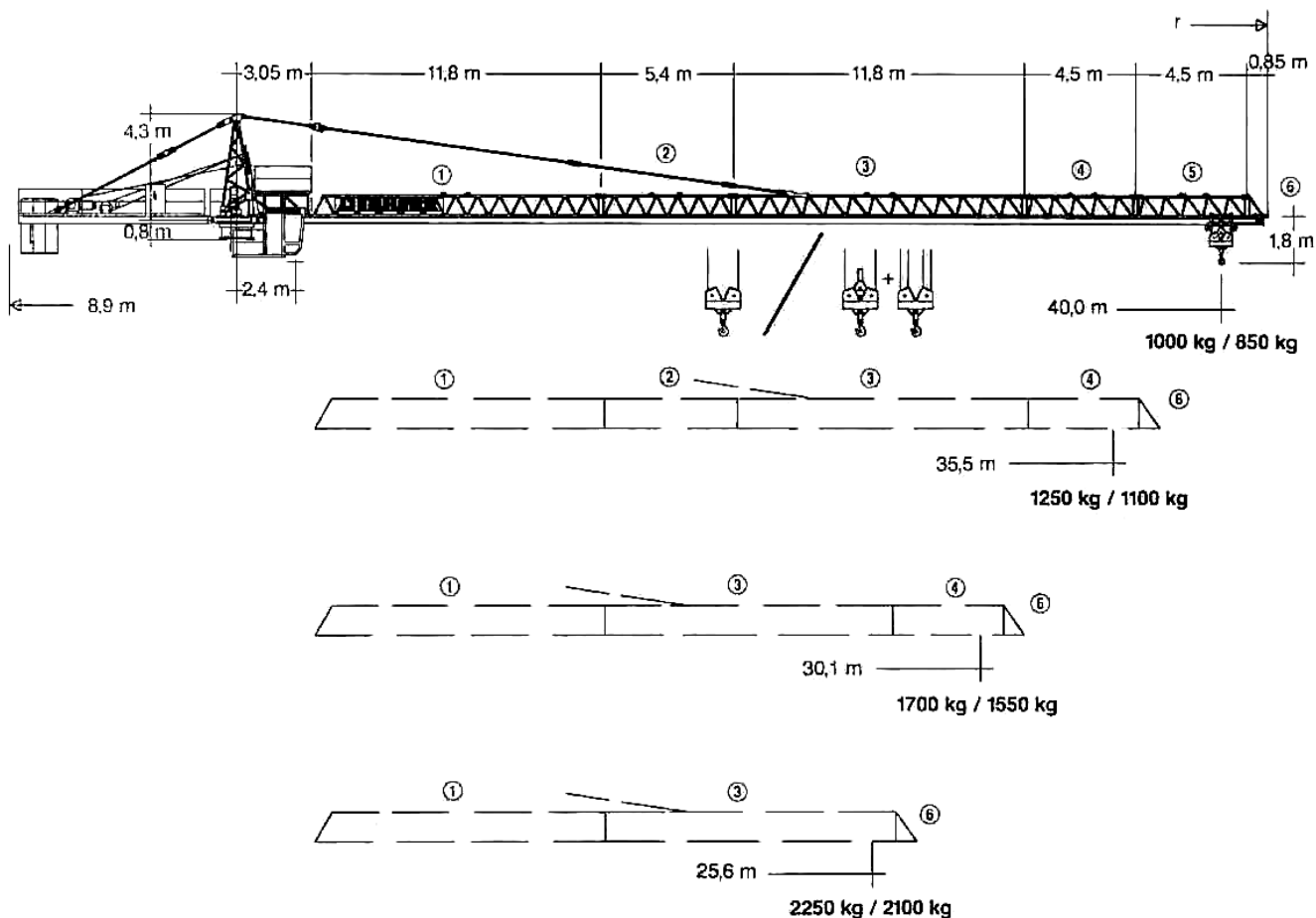

Wysokość podnoszenia:

Z wieżą		45 EC					
Łącznie z wstawką wieży							
6 m	12 m	6.1	6.1	5.9	6.1	5.2	9.6
1	1	12.1	12.1	11.9	12.1	11.2	15.6
3		18.1	18.1	17.9	18.1	17.2	21.6
4	2	24.1	24.1	23.9	24.1	23.2	27.6
5		30.1	30.1	29.9	30.1	29.2	33.6
6	3	36.1	36.1	35.9	36.1	35.2	39.6



TADEX ŻURAWIE, 62-030 Luboń, ul. Dworcowa 47
 Tel. +48 61 8666 777, kom. +48 601 149 358
www.dzwigi-budowlane.pl, tadex@dzwigi-budowlane.pl



Tabela udźwigu:

Długość wysięgnika	max. kg	m/kg													
	m/kg				20,0	22,0	24,0	25,6	28,0	30,1	32,0	34,0	35,5	38,0	40,0
40,0 (r = 42,0)	2,4-19,1 2500				2360	2100	1880	1740	1560	1430	1320	1230	1160	1070	1000
35,5 (r = 37,5)	2,4-20,1 2500				2500	2240	2020	1870	1670	1530	1420	1320	1250		
30,1 (r = 32,1)	2,4-21,9 2500				2500	2480	2230	2070	1850	1700					
25,6 (r = 27,6)	2,4-23,4 2500				2500	2500	2430	2250							

m	r	m / kg		14,0	16,0	18,0	20,0	22,0	24,0	25,6	28,0	30,1	32,0	34,0	35,5	38,0	40,0
40,0	(r = 42,0)	2,4-21,5 2000	2,4-12,6 4000	3500	2940	2520	2200	1940	1730	1590	1410	1270	1170	1080	1010	920	850
35,5	(r = 37,5)	2,4-22,7 2000	2,4-13,3 4000	3750	3160	2710	2360	2090	1860	1710	1520	1380	1270	1170	1100		
30,1	(r = 32,1)	2,4-24,7 2000	2,4-14,4 4000	4000	3500	3010	2630	2330	2080	1920	1700	1550					
25,6	(r = 27,6)	2,4-25,6 2000	2,4-15,4 4000	4000	3820	3290	2870	2550	2280	2100							

Max. udźwig

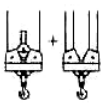











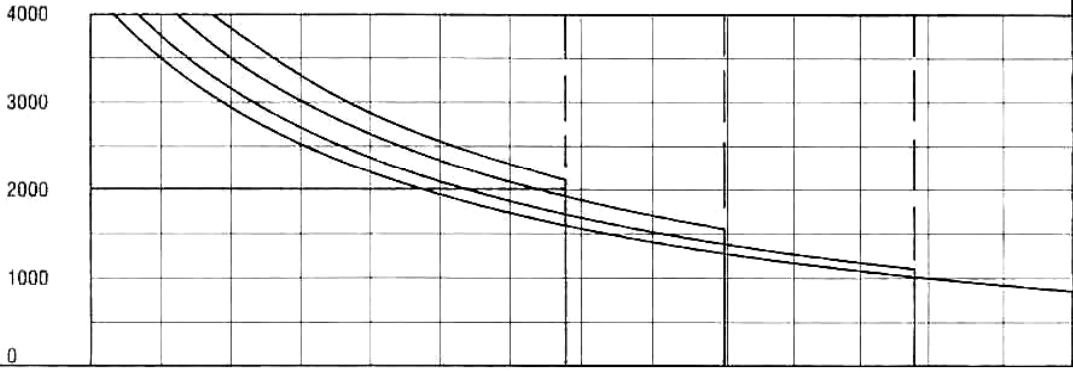







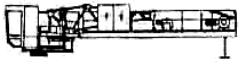

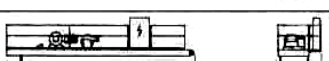
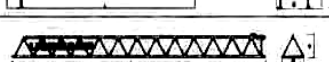

Tabela szybkości:

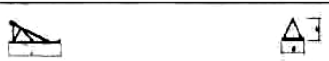
	U/min 0,8 sl/min tr./min	3,1 kW
	9,0/30,1/60,0 m/min	3,0 kW
	27,0 m/min	2 x 2,2 kW
Wymagana moc (górna część)		Wciągarka 15kW
kW		21,1
kVA		33,0

Wciągarka	Moc	kg	m/min.
15,0/10,8/2,5 kW 38,5 wysokość podnoszenia (5 warstw)	 1 2500 2 2500 3 1350	 2000 2000 1350	6,0
			26,0
			48,0
	 1 2 3	4000 4000 2700	3,0
			13,0
			24,0

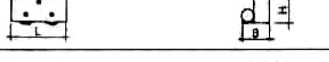

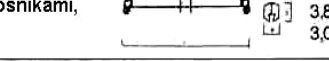
Wymiary i wagi:

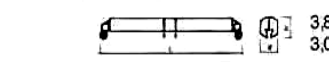
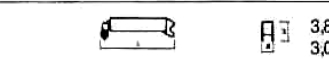
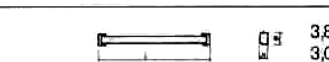
L.p	ilość	Górna część		L (m)	B (m)	H (m)	kg	
1	1	Maszynownia z kabiną		12,00	2,44	2,38	6500	
2	1	Kabina z podestem		3,10	1,30	2,20	610	
3	1	Mechanizm obrotu		4,10	1,80	1,90	2930	
4	1	Górna element wieży		4,30	1,00	1,20	630	
5	1	Przeciwwyścięgnik		8,00	1,80	2,00	2220	
6	1	Wyścięgnik (element)		12,00	0,97	1,20	1120	
7	2	Wyścięgnik (element)		4,70	0,97	1,00	220	
1	12,00			0,97	1,20	990		
1	5,60			0,97	1,00	430		
8	1	Wyścięgnik (element)		0,90	0,97	1,00	120	
9	1	Hak ładowania		1,30	0,93	0,26	285	
Wieża								
10	3	Wstawka wieży 12,0m		12,00	1,20	1,20	2520	
11	6	Wstawka wieży 6,0m		6,00	1,20	1,20	1440	
12	3,00			1,20	1,20	1000		
Przeciwwaga								
12	2	Wózek z napędem		0,75	0,55	0,55	260	
13	2	Wózek bez napędu		0,65	0,30	0,55	350	
14	1	Podstawa krzyżowa z podnośnikami, długie ramie		3,8 m	5,80	0,60	0,70	1515
				3,0 m	4,70	0,60	0,80	1625
15	2	Podstawa krzyżowa z podnośnikami, krótkie ramie		3,8 m	2,85	0,60	0,70	760
				3,0 m	2,30	0,60	0,80	775
16	1	Podstawa krzyżowa jezdna, długie ramie		3,8 m	5,60	0,60	0,80	1435
				3,0 m	4,50	0,60	0,90	1510
17	2	Podstawa krzyżowa jezdna, krótkie ramie		3,8 m	2,75	0,60	0,80	720
				3,0 m	2,20	0,60	0,90	730
18	4	Podstawa krzyżowa jezdna,		3,8 m	3,40	0,20	0,10	75
				3,0 m	2,60	0,60	0,35	90

Transport:

Transport z max. wysokość haka i max. promieniem

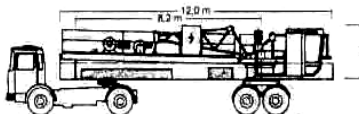
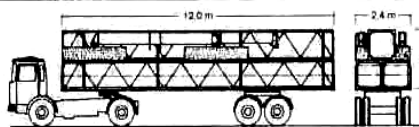
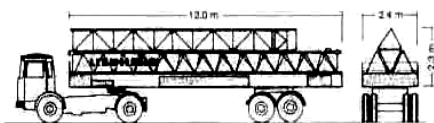

TADEX ŻURAWIE, 62-030 Luboń, ul. Dworcowa 47
Tel. +48 61 8666 777, kom. +48 601 149 358

www.dzwigi-budowlane.pl, tadex@dzwigi-budowlane.pl

